

**EO**<sup>®</sup>  
*Original Parts*

# Mercedes Truck Parts

*Parts Catalogue*



*Vol. 10  
Sept. 2022*

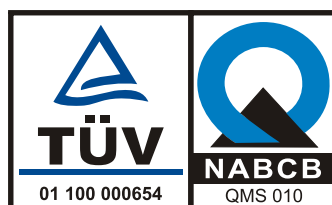

An ISO 9001:2008 Certified Co.

# Truck Parts



**KING PIN KIT (1/2 KIT) EOKPK-01**  
O.E.M. PART No. 391 330 00 19/1  
OM 355 A (TURBO), OM 402  
PIN SIZE - 50 / 51 mm



**KING PIN KIT EOKPK-02**  
OM 355  
O.E.M PART No. 343 330 02 19/2  
PIN SIZE - 45 / 46 mm



**KING PIN KIT EOKPK-03**  
O.E.M. PART No. 360 330 0619  
OM 303,3107,1013,1017,1919,1213,1413  
PIN SIZE - 38 mm



**KING PIN KIT EOKPK-04**  
O.E.M. PART No. 360 330 0719  
OM 302, 1113, 810, 911B  
PIN SIZE - 36.65 mm



**KING PIN KIT EOKPK-42**  
O.E.M. PART No. 310 330 1219 / 66833000019  
OM 309, 407, 709, 809, 811D  
PIN SIZE - 27 x 154



**KING PIN KIT EOKPK-15**  
O.E.M. PART No. 340 330 0019  
PIN SIZE - Forging Type



**KING PIN KIT EOKPK-31**  
O.E.M. PART No. 6553300519 / S1  
ACTROS (ROLLER BEARING)  
PIN SIZE - 50 x 223 mm



**KING PIN KIT EOKPK-32**  
O.E.M. PART No. 6553300419 / S1  
ACTROS (THRUST BEARING)  
PIN SIZE - 54 x 223 mm



**KING PIN KIT EOKPK-30**  
OM 364  
PIN SIZE - 30 x 171.2 mm



**KING PIN KIT SPRINTER**  
O.E.M. PART No. A6013300319  
OM 207, 208, 209, 210, 307, 308  
PIN SIZE - 23 x 132 mm



**KING PIN KIT SPRINTER**  
O.E.M. PART No. A6013300019  
OM 207, 208, 209, 210, 307, 308  
PIN SIZE - 23 x 132 mm



**KING PIN KIT SPRINTER EOKPK-54**  
O.E.M. PART No. A6113300019  
PIN SIZE - 26 x 136 mm

# Truck Parts



**KING PIN KIT** **EOKPK-37**  
O.E.M. PART No. 612 609 0814  
PIN SIZE - 31.8 x 25.3 x 167 mm



**KING PIN KIT** **EOKPK-57**  
O.E.M. PART No. 316 330 0119  
PIN SIZE - 30 x 186.5 mm



**REPAIR KIT, BRAKE SHOE**  
O.E.M. PART No. 395 420 0082



**REPAIR KIT, BRAKE S-CAM**  
O.E.M. PART No.  
360 420 0341, 360 420 0441



**SPRING PIN** **EOSP-25**  
FRONT (FULL KIT)  
O.E.M. PART No. 3953200265



**SPRING PIN** **EOSP-26**  
SET REAR (FULL KIT)  
O.E.M. PART No. 3893200065



**SPRING PIN** **EOSP-27**  
SET REAR (FULL KIT)  
O.E.M. PART No. 6583200065



**FUEL TANK CAP**  
NON LOCKING - 78 mm



**WINDOW REGULATOR HANDLE**  
O.E.M. PART No. 381 725 0060 / 43



**ACCELERATOR PEDAL**  
O.E.M. PART No. 624 300 0304  
CABIN - 381, 641



**ACCELERATOR PEDAL**  
O.E.M. PART No. 352 300 08 02 SP  
CABIN - 325, 328, 335



**ACCELERATOR END**  
6 mm to 10 mm

## Truck Parts

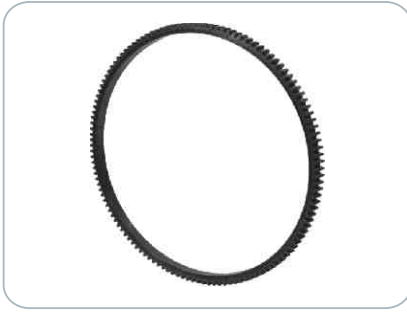

**FLYWHEEL RING GEAR**  
Ref. Catalogue - All Models



**SPRING**  
O.E.M. PART No. 3039930410



**SPRING**  
O.E.M. PART No. 3269930010

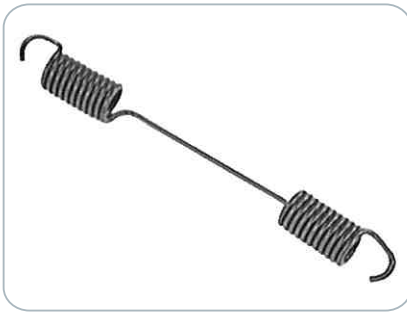

**SPRING**  
O.E.M. PART No. 3354210192

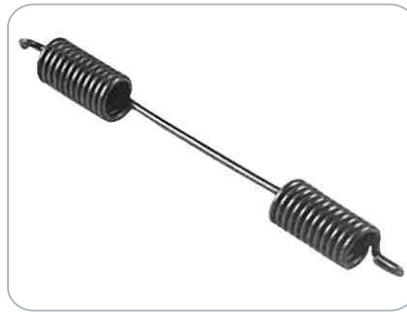

**SPRING**  
O.E.M. PART No. 3469930310

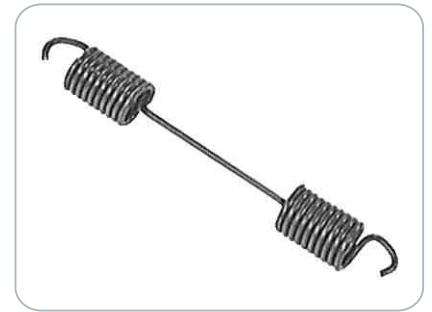

**SPRING**  
O.E.M. PART No. 3469930810



**SPRING**  
O.E.M. PART No. 6179930610



**SHACKLE**  
O.E.M. PART No. 3873200162



**SPRING HANGER, REAR AXLE**  
O.E.M. PART No. 387 325 0001



**SPRING BRACKET MOUNTING**  
O.E.M. PART No. 625 325 0219  
EO PART No.: EODB208



**BRACKET**  
O.E.M. PART No. 3353250603



**SHACKLE**  
O.E.M. PART No. 3463205063

# Truck Parts



**SPRING BRACKET MOUNTING**  
O.E.M. PART No. 625 325 0319  
EO PART No.: EODB207



**EOMTG225**                      **MERCEDES**  
Mounting  
OEM No.: 352400417



**ENGINE MOUNTING**  
O.E.M. PART No. 6152400317



**ENGINE MOUNTING**  
O.E.M. PART No. 0002410513  
EO PART No.: EOMTG1005



**Part No. 9423171812**  
Bush, Drive, Cabin, Suspension



**Radiator Mounting**  
Part No. 3475040012



**ENGINE MOUNT REAR 16X12**  
O.E.M. PART No. 6452400218  
EO PART No.: EOMTG1013



**ENGINE MOUNT REAR 18X14**  
O.E.M. PART No. 6452400618  
EO PART No.: EOMTG1014



**RUBBER MOUNTING**  
O.E.M. PART No. 6202400717  
EO PART No.: EOMTG1023



**RUBBER MOUNTING**  
O.E.M. PART No. 9412415113  
EO PART No.: EOMTG1006



**RUBBER MOUNTING**  
O.E.M. PART No. 6172400217  
EO PART No.: EOMTG1004



**RUBBER MOUNTING**  
O.E.M. PART No. 0002421213  
EO PART No.: EOMTG1027

## Truck Parts



**RUBBER MOUNTING**  
O.E.M. PART No. 6582410013  
EO PART No.: EOMTG1022



**MOUNTING ACTROS/ATEGO**  
O.E.M. PART No. 0003250896  
EO PART No.: EOMTG1015



**HUB PULLEY (LONG)**  
O.E.M. PART No. 4042000226  
EO PART No.: EOTR12



**REPAIR KIT CABIN HINGE**  
O.E.M. PART No. 3873100077  
EO PART No.: EOMTG1031



**SECTION HOSE**  
O.E.M. PART No. 6455280182  
EO PART No.: EOH01



**AIR INTAKE HOSE**  
O.E.M. PART No. 6205280782



**MERCEDES**  
Part No. 3185860031  
Repair Kit Cabin Mounting



**Gear Lever Repair Kit**  
Part No. 3852681474



**BUSHING**  
O.E.M. PART No. 0009921603



**SPRING, GREY**  
O.E.M. PART No. 6208910151  
EO PART No.: EOSSP057



**REPAIR KIT CABIN STABILIZER**  
O.E.M. PART No. 3875860531  
EO PART No.: EOMTG1030



**SPRING PLATE**  
O.E.M. PART No. 3873510026  
EO PART No.: EOBRKT07

# Truck Parts



**ENGINE MOUNTING**  
O.E.M. PART No. 3432410013  
EO PART No.: EOMTG1005A



**ENGINE MOUNTING**  
O.E.M. PART No. 6522400318  
EO PART No.: EOMTG1003



**BEARING BUSHING 70X40**  
O.E.M. PART No. 0003237985  
EO PART No.: EOBH558



**BEARING BUSHING 80x40**  
O.E.M. PART No. 0003238185  
EO PART No.: EOBH555



**BEARING BUSH, STABILIZER**  
O.E.M. PART No. 9413260050  
EO PART No.: EOBH556



**RUBBER MOUNTING**  
O.E.M. PART No. 0003223285  
EO PART No.: EOBH557



**MOUNTING PROP SHAFT 70MM**  
O.E.M. PART No. 6564110012  
EO PART No.: EOMTG1020



**ENGINE MOUNTING FRONT/REAR**  
O.E.M. PART No. 9412417713  
EO PART No.: EOMTG1007



**FRONT SPRING BRACKET**  
O.E.M. PART No. 6203220901  
EO PART No.: EOBKRT04



**CARRIER, BRAKE CALIPER, RED**  
O.E.M. PART No. 3464230906  
EO PART No.: EOACB202



**BUSH, LEAF SPRING**  
O.E.M. PART No. 0003250485  
EO PART No.: EOBH586



**RUBBER MOUNTING**  
O.E.M. PART No. 0003262681  
EO PART No.: EOMTG1024

## Truck Parts



**CYLINDER HEAD**  
O.E.M. PART No. 4290100220  
EO PART No.: EOE33



**CYLINDER HEAD 2876 ENGINE**  
O.E.M. PART No. 51031006053  
EO PART No.: EOE34



**CYLINDER HEAD OM 501 LA**  
O.E.M. PART No. 5410105320  
EO PART No.: EOE35



**CYLINDER HEAD OM366A TURBO**  
O.E.M. PART No. 3660102920  
EO PART No.: EOE38



**CYLINDER HEAD OM442/OM446**  
O.E.M. PART No. 4420100620  
EO PART No.: EOE39



**CYLINDER HEAD**  
O.E.M. PART No. 9060107621  
EO PART No.: EOE40



**CYL. HEAD OM352 NON-TURBO**  
O.E.M. PART No. 3520105220  
EO PART No.: EOE41



**CYLINDER HEAD OM355**  
O.E.M. PART No. 3550100220  
EO PART No.: EOE51



**CYLINDER HEAD OM355A**  
O.E.M. PART No. 3550100620  
EO PART No.: EOE52



**CRANKSHAFT, OLD MODEL-SCROLLD**  
O.E.M. PART No. 3520303402  
EO PART No.: EOE-16



**CRANKSHAFT, WITH BORGMANRING**  
O.E.M. PART No. 3520303702  
EO PART No.: EOE-17



**CAMSHAFT OM355 R6-128**  
O.E.M. PART No. 3550510401  
EO PART No.: EOE18



# Truck Parts



**SPRING BRAKET**  
O.E.M. PART No. 6243250110  
EO PART No.: EOBKR06



**SPRING BRAKET**  
O.E.M. PART No. 3463225001  
EO PART No.: EOBKR08



**MOUNTING LEAF SPRING**  
O.E.M. PART No. 3833250112  
EO PART No.: EOBKR09



**MOUNTING LEAF SPRING**  
O.E.M. PART No. 3953250312  
EO PART No.: EOBKR010



**DRIVE FLANGE CROSS HOLDER**  
O.E.M. PART No. 656 411 03 11,  
656 411 00 11  
**EOPPS-051**  
U.J.CROSS 57mm  
Alternate teeth  
Ø 180mm  
4 Bolt



**DRIVE FLANGE CROSS HOLDER**  
O.E.M. PART No. 395 411 09 11,  
395 411 10 11  
**EOPPS-052**  
U.J.CROSS 68mm  
Alternate teeth  
Ø 180mm  
4 Bolt



**DRIVE FLANGE CROSS HOLDER**  
O.E.M. PART No. 395 411 02 11,  
395 411 08 11, 363 411 01 11  
**EOPPS-053**  
U.J.CROSS 57mm  
10 Bolt / M16  
Ø 180mm



**DRIVE FLANGE CROSS HOLDER**  
O.E.M. PART No. 395 411 00 11,  
387 411 00 11, 387 411 01 11  
**EOPPS-054**  
U.J.CROSS 53mm  
10 Bolt / M16  
Ø 180mm



**DRIVE FLANGE CROSS HOLDER** U.J.CROSS 53mm  
O.E.M. PART No. 363 411 02 11, 8 Bolt / M16  
389 411 00 11, 389 411 02 11 Ø 165mm  
**EOPPS-055**



**DRIVE FLANGE CROSS HOLDER** U.J.CROSS 53mm  
O.E.M. PART No. 346 411 00 11 8 Bolt / M14  
**EOPPS-056** Ø 165mm



**DRIVE FLANGE CROSS HOLDER** U.J.CROSS 52mm  
O.E.M. PART No. 335 411 02 11 8 Bolt / M14  
**EOPPS-057** Ø 165mm



**DRIVE FLANGE CROSS HOLDER** U.J.CROSS 45mm  
O.E.M. PART No. 336 411 00 11, 8 Bolt / M12  
343 411 00 11 Ø 150mm  
**EOPPS-058**



**DRIVE FLANGE CROSS HOLDER** U.J.CROSS 38mm  
O.E.M. PART No. 312 411 11 11 Ø 120mm  
**EOPPS-059**



**GEAR BOX OUTPUT FLANGE** 10 BOLT - M16  
O.E.M. PART No. 346 350 05 45, DIN 5480 65x61  
000 262 10 45, 1285 338 004 Z 31 - Ø 180mm  
**EOCP-051**



**AXLE FLANGE** 4 BOLT  
O.E.M. PART No. 346 350 14 45 Ø 180mm, Z - 31  
**EOCP-052** DIN 5480 65x61  
STAGGERED TEETH



**AXLE FLANGE** 8 BOLT - M14  
O.E.M. PART No. 346 350 06 45 Ø 165mm  
**EOCP-053** Z - 31  
DIN 5480 65x61

# Truck Parts



**AXLE FLANGE** Z - 31  
O.E.M. PART No. 346 350 04 45 Ø 165mm  
81.39115-5030, 346 350 08 45 8 BOLT - M16  
**EOCP-054** DIN 5480 65x61



**GEAR BOX OUTPUT FLANGE** 8 BOLT - M16  
O.E.M. PART No. 000 264 08 45 - RVI DIN-5480 70x66  
81.39115-0137, 1269 338 028 Z - 34  
**EOCP-055** Ø 165mm



**GEAR BOX OUTPUT FLANGE** 8 BOLT - M14  
O.E.M. PART No. 1268 304 148 DIN-5480 70x66  
000 264 14 45 Z - 34  
**EOCP-056** Ø 165mm



**GEAR BOX OUTPUT FLANGE** 10 BOLT - M16  
O.E.M. PART No. 000 264 09 45 DIN-5480 70x66  
1269 338 020, 81.39115-0120 Z - 34  
**EOCP-057** Ø 180mm



**GEAR BOX ZF OUTPUT FLANGE** 4 BOLT  
O.E.M. PART No. 000 264 36 45 Z - 36, Ø 180mm  
1295 338 061, DAF 698 639, DIN 5480 71x75  
IVECO 8194837 **EOCP-058** STAGGERED TEETH



**GEAR BOX ZF OUTPUT FLANGE** 10 BOLT - M16  
O.E.M. PART No. 1295 338 059 Z - 36, Ø 180mm  
000 264 37 45, 81.39115-0214 DIN 5480 71x75  
**EOCP-059**



**GEAR BOX ZF OUTPUT FLANGE** 10 BOLT - M16  
O.E.M. PART No. 000 264 41 45 Z - 38, Ø 180mm  
1297 338 038, 81.39115-0213 DIN 5480 80x76  
1284534 - DAF **EOCP-060**



**GEAR BOX ZF OUTPUT FLANGE** 4 BOLT  
O.E.M. PART No. 000 264 42 45 Z - 38, Ø 180mm  
1297 338 041, 689335-DAF DIN 5480 80x76  
81.39115-0213 **EOCP-061** STAGGERED TEETH



**DIFFERENTIAL AXLE FLANGE** 8 BOLT - M16  
O.E.M. PART No. 355 350 06 45 Ø 165mm  
81.39115-5025 Z - 28  
**EOCP-062** DIN 5482 60x55



**DIFFERENTIAL AXLE FLANGE** 10 BOLT - M16  
O.E.M. PART No. 355 350 07 45 Ø 180mm  
81.39115-5026 Z - 28  
**EOCP-063** DIN 5482 60x55



**DIFFERENTIAL AXLE FLANGE** 48 BOLT  
O.E.M. PART No. 355 353 23 45 Ø 180mm, Z - 28  
355 350 13 45, 355 350 12 45, DIN 5482 60x55  
81.39115-5067 **EOCP-064** STAGGERED TEETH



**DIFFERENTIAL AXLE FLANGE** 8 BOLT - M14  
**RITZEL AXLES** Ø 165mm  
O.E.M. PART No. HL 6/4D-13, 1924 Z - 28  
366 353 00 45 **EOCP-065** DIN 5482 60x55



**OUTPUT FLANGE** Z - 26  
O.E.M. PART No. 343 282 0545 Ø 150mm  
**EOCP-066** 8 BOLT - M12  
DIN 5482 55x50



**AXLE FLANGE** 8 BOLT - M12  
**RITZEL AXLES** Ø 150mm  
O.E.M. PART No. HD 6/3DG-10,2624 Z - 26  
315 353 00 45 **EOCP-067** DIN 5482 55x50



**AXLE FLANGE** 10 BOLT - M16  
O.E.M. PART No. 355 353 12 45 Ø 180mm  
81.39115-0087 Z - 26  
**EOCP-068** DIN 5480 55x51



**AXLE FLANGE** 8 BOLT - M16  
O.E.M. PART No. 355 353 14 45 Ø 165mm  
81.39115-0086 Z - 26  
**EOCP-069** DIN 5480 55x50

# Truck Parts



**CENTRE FLANGE**  
O.E.M. PART No. 335 410 01 30  
**EOCP-070**

8 BOLT - M14  
Ø 165mm  
Z - 26  
DIN 5482 55x50



**CENTRE FLANGE**  
O.E.M. PART No. 336 410 00 30  
**EOCP-071**

8 BOLT - M12  
Ø 150mm  
Z - 26  
DIN 5482 55x50



**CENTRE FLANGE**  
O.E.M. PART No. 645 411 00 46  
645 410 00 30  
**EOCP-072**

4 BOLT, Z - 26  
Ø 180mm  
DIN-5480 70x65  
STAGGERED TEETH



**CENTRE FLANGE**  
O.E.M. PART No. 395 410 01 30  
387 411 04 46  
**EOCP-073**

10 BOLT - M16  
Ø 180mm  
Z - 26  
DIN-5480 70x65



**DIFFERENTIAL AXLE FLANGE**  
O.E.M. PART No. 355 353 2445  
**EOCP-074**

4 BOLT  
Z - 26, Ø 165mm  
DIN 5480 55x51  
STAGGERED TEETH



**OUTPUT FLANGE**  
O.E.M. PART No. 343 260 00 17  
**EOCP-075**

8 BOLT - M12  
Z - 8  
Ø 150mm



**OUTPUT FLANGE**  
O.E.M. PART No. 366 260 00 17  
**EOCP-076**

Z - 8  
Ø 165mm  
8 BOLT - M14



**COUPLING FLANGE P.T.O**  
O.E.M. PART No. 81.32711-0001  
343 264 0045 / 1238 310 013  
**EOCP-077**

Z - 8  
Ø 100mm  
6 BOLT  
UN1220 32x36



**GEAR BOX FLANGE P.T.O.**

O.E.M. PART No. 343 264 0045  
1238 310 013  
**EOCP-078**

Z - 8  
Ø 90mm  
4 BOLT  
UN1220 32x36



**GEAR BOX OUTPUT FLANGE**

O.E.M. PART No. 81.39115-0156  
000 262 07 45/1268 304 136  
**EOCP-079**

16 BOLT - M12  
Ø 150mm  
Z - 34  
DIN 5480 70x66



**CENTRE FLANGE**

O.E.M. PART No. 346 410 00 30  
**EOCP-080**

8 BOLT - M14  
Ø 165mm  
Z - 22  
DIN 5480 60x55



**CENTRE FLANGE**

O.E.M. PART No. 346 410 99 30  
**EOCP-081**

8 BOLT - M16  
Ø 165mm  
Z - 22  
DIN 5480 60x55



**CENTRE FLANGE**

O.E.M. PART No. 389 411 00 46  
389 410 01 30  
**EOCP-082**

4 BOLT  
Ø 180mm, Z - 22  
DIN 5480 60x55  
STAGGERED TEETH



**CENTRE FLANGE**

O.E.M. PART No. 395 410 00 30  
389 411 01 46  
**EOCP-083**

10 BOLT - M16  
Ø 180mm  
Z - 22  
DIN 5480 60x55



**FLANGE - OM-309**

O.E.M. PART No. 309 350 03 45  
**EOCP-084**

Z - 17  
Ø 120mm  
6 BOLT



**CENTRE FLANGE - OM-314**

O.E.M. PART No. 314 410 0430  
**EOCP-085**

Z - 14  
Ø 120mm  
6 BOLT

# Truck Parts



**GEAR FLANGE - OM-314**  
O.E.M. PART No. 316 350 0045  
**EOCP-086**

Z - 14  
Ø 120mm  
6 BOLT



**FLANGE - OM-314**  
O.E.M. PART No. 314 262 0145  
**EOCP-087**

Z - 13  
Ø 120mm  
6 BOLT



**FLANGE - OM-352**  
O.E.M. PART No. 322 262 0045  
**EOCP-088**

Z = 16  
Ø 120mm  
6 BOLT



**FLANGE**  
O.E.M. PART No. 1249 304 613  
**EOCP-089**

Z = 18  
Ø 120mm  
6 BOLT



**FLANGE - OM-314**  
O.E.M. PART No. 1249 304 613  
310 410 0230  
**EOCP-090**

Z = 18  
Ø 120mm  
6 BOLT



**DIFFERENTIAL COUPLING**  
O.E.M. PART No. 358 350 0045  
**EOCP-091**

Z = 26  
Ø 120mm  
6 BOLT



**FLANGE**  
O.E.M. PART No. 942 353 1245  
**EOCP-094**

4 HOLE  
200 MM  
31 Z



**FLANGE**  
O.E.M. PART No. 346 350 1645  
**EOCP-095**

4 HOLE  
200 MM  
31 Z



**FLANGE YOKE & TEETH** U.J. CROSS 57mm  
O.E.M. PART No.  
**EOPPS-060**



**FLANGE YOKE & TEETH** U.J. CROSS 53mm  
O.E.M. PART No.  
**EOPPS-061**



**SLEEVE YOKE & TEETH** Z = 10  
O.E.M. PART No. 3210 410 3402 U.J. CROSS Ø38mm  
**EOPPS-062**



**SLEEVE YOKE & TEETH** Z = 20  
O.E.M. PART No. 321 410 3402 U.J. CROSS Ø38mm  
**EOPPS-063**

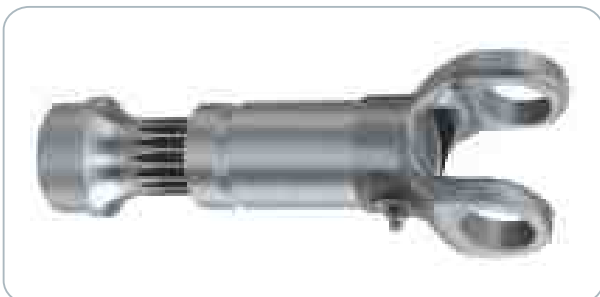

**SLEEVE YOKE & TEETH** Z = 16  
O.E.M. PART No. 321 410 3402 U.J. CROSS Ø38mm  
**EOPPS-064**



**COUPLING SHAFT - OM-314** Z = 18  
O.E.M. PART No. 309 410 0008 Ø 64 mm PIPE SIZE  
**EOPPS-065** BEARING 35 mm



**COUPLING & FRONT TEETH** Z = 18  
Model No. OM-314 Ø 64mm PIPE SIZE  
**EOPPS-066** BEARING 35mm

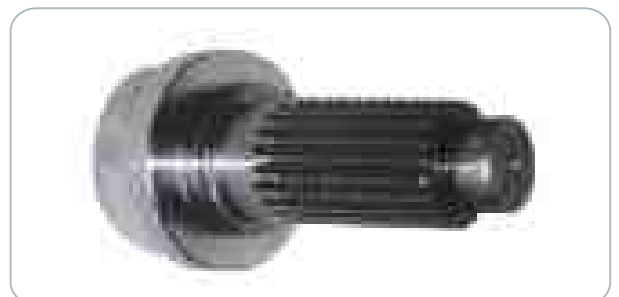

**COUPLING SHAFT** Z = 22  
O.E.M. PART No. 346 410 99 99 PIPE Ø 98mm  
**EOPPS-067** BEARING 60mm  
DIN 5480 60x55



# Truck Parts

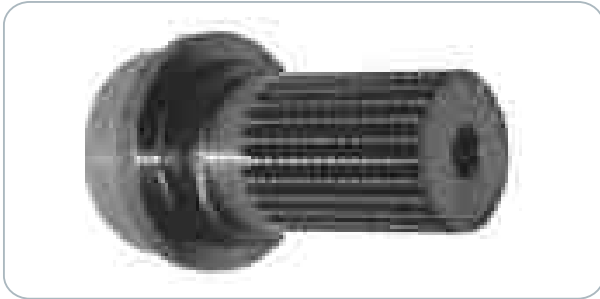

**COUPLING SHAFT**  
O.E.M. PART No. 395 410 99 99  
**EOPPS-068**

Z = 26  
PIPE Ø 98mm  
BEARING 70mm  
DIN 5480 70x65

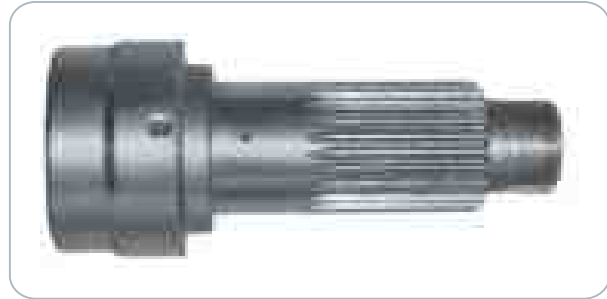

**COUPLING SHAFT**  
O.E.M. PART No. 336 410 99 99  
**EOPPS-069**

Z = 26  
PIPE Ø 90mm  
BEARING 55mm  
DIN 5482 55x50



**COUPLING SHAFT BEARING**  
O.E.M. PART No. 314 410 0208  
**EOPPS-070**

Z - 14  
Ø 64mm PIPE SIZE  
BEARING 40mm



**OUTSIDE GEAR**  
O.E.M. PART No. 346 354 09 09  
81.351140020  
**EOWH-50**

Z = 57  
H = 40mm  
INTERNAL TEETH 46



**OUTSIDE GEAR**  
O.E.M. PART No. 346 354 10 09  
81.35114-0035  
**EOWH-201**

Z = 56  
H = 66mm  
INTERNAL TEETH 46



**OUTSIDE GEAR**  
O.E.M. PART No. 346 354 11 09  
81.35114-0034  
**EOWH-33**

Z = 57  
H = 66mm  
INTERNAL TEETH 46



**OUTSIDE GEAR**  
O.E.M. PART No. 346 354 23 09  
**EOWH-202**

Z = 48  
H = 54mm  
INTERNAL TEETH 46



**OUTSIDE GEAR**  
O.E.M. PART No. 346 354 24 09  
**EOWH-203**

Z = 48  
H = 28mm  
INTERNAL TEETH 46



**OUTSIDE GEAR WITH SLOT**                      Z = 48  
FOR RETAINING RING                              H = 54mm  
O.E.M. PART No. 346 354 27 09              INTERNAL TEETH 46  
**EOWH-204**



**OUTSIDE GEAR WITH SLOT**                      Z = 48  
FOR RETAINING RING                              H = 28mm  
O.E.M. PART No. 346 354 28 09              INTERNAL TEETH 46  
**EOWH-205**



**OUTSIDE GEAR WITH SLOT**                      Z = 57  
FOR RETAINING RING                              H = 66mm  
O.E.M. PART No. 346 354 30 09              INTERNAL TEETH 46  
**EOWH-206**



**OUTSIDE GEAR WITH SLOT**                      Z = 57  
FOR RETAINING RING                              H = 40mm  
O.E.M. PART No. 346 354 31 09              INTERNAL TEETH 46  
**EOWH-207**



**OUTSIDE GEAR WITH SLOT**                      Z = 89  
FOR RETAINING RING                              H = 66mm  
O.E.M. PART No. 346 354 42 09              INTERNAL TEETH 46  
**EOWH-208**



**OUTSIDE GEAR WITH SLOT**                      Z = 89  
FOR RETAINING RING                              H = 40mm  
O.E.M. PART No. 346 354 43 09              INTERNAL TEETH 46  
**EOWH-209**



**OUTSIDE GEAR WITH SLOT**                      Z = 85  
**FOR RETAINING RING**                              H - 66mm  
O.E.M. PART No. 346 354 57 09              INTERNAL TEETH 46  
**EOWH-210**



**OUTSIDE GEAR WITH SLOT**                      Z = 85  
**FOR RETAINING RING**                              H - 28mm  
O.E.M. PART No. 346 354 58 09              INTERNAL TEETH 46  
**EOWH-211**

# Truck Parts



**OUTSIDE GEAR**  
O.E.M. PART No. 355 354 07 09  
81.3514-0019, 81.35114-0019  
**EOWH-212**

Z - 56  
H - 40mm  
INTERNAL TEETH 46



**REAR SLEEVE**  
O.E.M. PART No. 320 357 00 53  
**EOPPS-071**

Z = 24  
DIN 5480 50x46  
RITZEL AXLE  
HD 6/3DG-10, 2624



**REAR SLEEVE**  
O.E.M. PART No. 366 357 00 53  
**EOPPS-072**

Z = 26  
DIN 5480 55x51  
RITZEL AXLE  
HL 6/4D-13, 1924



**DRIVE SHAFT**  
O.E.M. PART No. 335 357 01 02  
335 357 00 01, 335 357 00 02  
**EOPPS-073**

Z - 24  
DIN 5480 50x46  
RITZEL AXLES  
HD 6/3DG-10, 2624



**DRIVE SHAFT**  
O.E.M. PART No. 366 357 03 02  
366 357 00 01  
**EOPPS-074**

Z - 26  
RITZEL AXLES  
HL 6/4D-13, 1924  
DIN 5480 55x51



**UNIVERSAL JOINT**  
Ø 23.4 mm  
O.E.M. PART No. C134, 5176  
**EOPPS-075**

KEY COUPLING  
Ø 1"



**CARDAN JOINT**  
O.E.M. PART No. 000 460 01 57/425 460 01 57  
000 460 00 57/425 460 04 57  
381 460 00 57/421 460 04 57, 425 460 0057  
**EOPPS-076**



**UNIVERSAL JOINT**  
Ø 22mm WITH SLEEVE  
SAE 1 3/8"  
O.E.M. PART No. 129 002  
**EOPPS-077**

Z - 6  
SHAFT FITTING 32.50mm



**UNIVERSAL JOINT** FLANGE Ø 100mm  
Ø 22mm WITH FLANGE 6 BOLT - M8  
O.E.M. PART No. 129 001 SHAFT FITTING 26.50mm  
**EOPPS-078**



**CARDAN JOINT**  
O.E.M. PART No. 352 460 00 57  
**EOPPS-079**



**SENSOR RING** 150x196x16mm  
O.E.M. PART No. 1250882  
**EOEPA-110**



**SENSOR RING** 160x188x12mm  
O.E.M. PART No. 1254680  
**EOEPA-111**



**RACE**  
O.E.M. PART No. 314 035 02 14  
**EOTR-14**



**SPACER RING** 143x1 2.5x24  
O.E.M. PART No. 387 325 01 62  
**EOTR-15**



**SPACER RING** 189x1 15x24  
O.E.M. PART No. 389 325 10 62  
**EOTR-16**



**SPACER RING**  
O.E.M. PART No. 343 411 00 44  
**EOTR-17**

# Truck Parts



**THRUST RING** EOTR-01  
O.E.M. PART No. 3553561215  
Dimensions : 145 x 110 x 32



**THRUST RING** EOTR-02  
O.E.M. PART No. 3463561415  
Dimensions : 145 x 115 x 32



**THRUST RING** EOTR-03  
O.E.M. PART No. 9463560015  
**Actros/Atego** Dimensions: 145x119x26



**INTERMEDIATE RING** EOTR-04  
O.E.M. PART No. 4420310027  
Dimensions : 105 x 100 x 24



**THRUST RING (CONE OIL SEAL)**  
O.E.M. PART No. 321 356 0415  
SIZE - 100 x 73.5 x 16 mm



**THRUST RING (CONE OIL SEAL)**  
O.E.M. PART No. 383 356 0415  
SIZE - 120 x 100 x 18 mm



**INTERMEDIATE RING** EOTR-05  
O.E.M. PART No. 4030320309  
120x1115x21mm



**INTERMEDIATE RING with LIP** EOTR-06  
O.E.M. PART No. 4030310727  
105x1100x24mm



**THRUST RING** EOTR-18  
O.E.M. PART No. 346 356 02 15  
135x107x32mm



**THRUST RING** EOTR-20  
O.E.M. PART No. 407732  
195x114x21mm



**THRUST RING** 180x114x21mm  
O.E.M. PART No. 477331  
**EOTR-21**



**THRUST RING** 180x107x21mm  
O.E.M. PART No. 477521  
**EOTR-22**



**SPACER RING**  
O.E.M. PART No. 312 413 1231  
**EOTR-23**



**THRUST RING** 165x130x15/10mm  
O.E.M. PART No. 300360  
**EOTR-24**



**GROOVED NUT** M 112x1.5 P  
O.E.M. PART No. 346 353 0925  
**EOBN-501**



**NUT** M 135x1.5 P  
O.E.M. PART No. 355 353 0325  
81.35125-0005  
**EOBN-502**



**FLAT COLLAR NUT** M 90x2 P  
O.E.M. PART No. 389 325 2152  
**EOBN-503**



**THRUST WASHER**  
O.E.M. PART No. 304 334 0162  
**EOBN-504**



**CHECK NUT** **EOBN-505** M 60x1.5 P  
O.E.M. PART No. 000 990 2360 / 692208 - DAF  
073 750 2092 / 1526746 - VOLVO  
81.90620-0073 / 7982081 - IVECO

# Truck Parts



**HEXAGONAL NUT** M 55x1.5 P  
O.E.M. PART No. 346 353 0072  
**EOBN-507**



**HEXAGONAL NUT** **EOBN-508**  
O.E.M. PART No. 322 262 0072 / 322 262 0072  
322 411 7050 / 344 990 7050  
000 353 0272 / 004 990 1451 / 003 990 8651



**HEXAGONAL NUT** M 40x1.5 P  
O.E.M. PART No. 327 353 01 72  
385 351 01 72, 385 351 00 72  
**EOBN-509** RITZEL AXLES  
HD 6/3DG-10  
2624



**CROWN NUT** M 55x1.5 P  
O.E.M. PART No. 385 351 05 72 / 81.90685-0303  
946 351 00 72, 391836 - SCANIA  
**EOBN-510** RITZEL AXLES  
HD 6/3DG-10  
2624



**CROWN NUT** M 45x1.5 P  
O.E.M. PART No. 385 351 06 72  
81.90685-0311  
**EOBN-511** RITZEL AXLES  
HD 6/3DG-10  
2624



**HEXAGONAL NUT** M 45x1.5 P  
O.E.M. PART No. 366 353 0072  
81.90640-0032  
**EOBN-512** RITZEL AXLES  
HD 6/3DG-10  
2624



**HEXAGONAL NUT** M 55x1.5 P  
O.E.M. PART No. 346 353 0072  
81.90685-0052  
**EOBN-513**



**HEXAGONAL NUT** M 32x1.5 P  
O.E.M. PART No. 000 990 5050  
**EOBN-514**



## **EMPIRE COMPONENTS (P) LTD.**

**Regd. Office :** Khasra No. 2341, Sector-5 Road, Celebration Party Point,  
Gurugram-122001 Haryana (INDIA)  
Phone : +91 9810138100, +91 8800822090  
E-mail : [empireoverseas@rediffmail.com](mailto:empireoverseas@rediffmail.com), [rajiv.autosparesdirect@gmail.com](mailto:rajiv.autosparesdirect@gmail.com)  
Website : [www.empiretrading.in](http://www.empiretrading.in)